



Il profilo fissaggio frontale permette di installare frontalmente sia la zanzariera modello plissé 18 chela zanzariera modello plissé 22. Le dimensioni devono essere trasmesse in mm indicando base x altezza con le seguenti indicazioni.

✓ **MISURA FINITA:** Il profilo del fissaggio frontale verrà fornito con le dimensioni massimo ingombro, la zanzariera verrà fornita con dimensioni ridotte in relazione alla versione richiesta.



Esempio: misura max ingombro, la zanzariera verrà fornita con dimensioni ridotte di 30 mm in larghezza e 30 mm di altezza.

MISURA FINITA: la zanzariera verrà fornita con le stesse misure ordinate.

MISURA LUCE (SPECIFICARE): la zanzariera verrà fornita 3 mm in meno sul lato cassonetto.

COLORI PROFILI

Standard ■

- 01 Bianco 9010 
- 02 Avorio 1013 
- 03 Marrone 8017 
- 20 Bronzo Verniciato 
- 09 Argento OX 
- 06 Nero Opaco 9005 

FISSAGGIO CON VITE SEZ. ORIZZONTALE

Misura max ingombro

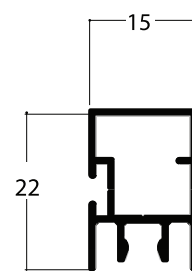
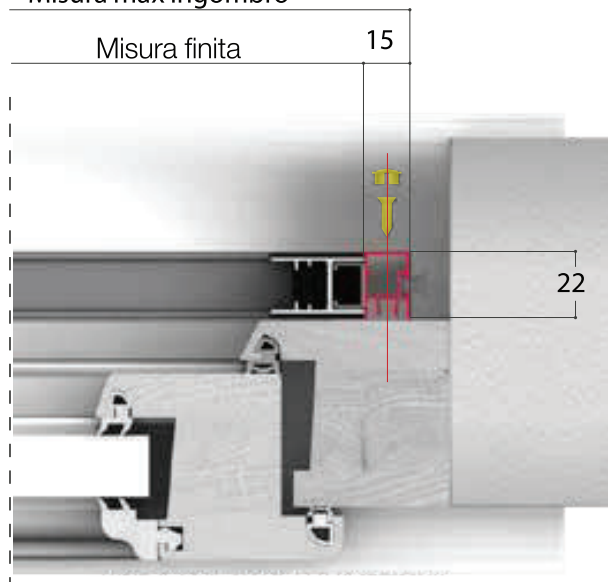

SPECIFICARE VERSIONE

versioni viste dall'esterno

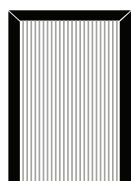

"A"

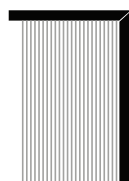

"B"

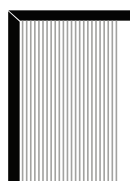

"C"

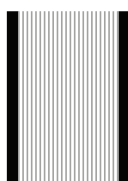

"D"

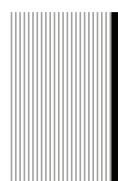

"E"

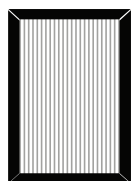

"F"

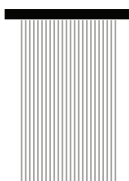

"G"

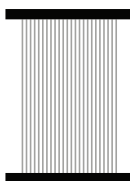

"H"

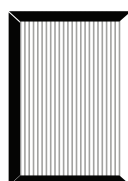

"I"